

BSP ШТУЦЕР 60°КОНУС

AGR

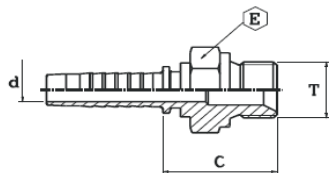

Код	Размер	рукава	Т (резьба)	d	E	C
	дюйм	мм				
0402000310	3/16	4,8	1/8-28	3,0	14	21
0402000313	3/16	4,8	1/4-19	3,0	19	26
0402000410	1/4	6,4	1/8-28	4,0	14	21
0402000413	1/4	6,4	1/4-19	4,0	19	27
0402000417	1/4	6,4	3/8-19	4,0	22	28
0402000421	1/4	6,4	1/2-14	4,0	27	32
0402000513	5/16	8,0	1/4-19	5,5	19	27
0402000517	5/16	8,0	3/8-19	5,5	22	28
0402000521	5/16	8,0	1/2-14	5,5	27	32
0402000617	3/8	9,5	3/8-19	7,0	22	29
0402000621	3/8	9,5	1/2-14	7,0	27	32
0402000817	1/2	12,7	3/8-19	9,5	22	29
0402000821	1/2	12,7	1/2-14	9,5	27	33
0402000823	1/2	12,7	5/8-14	9,5	30	34
0402000827	1/2	12,7	3/4-14	9,5	32	35
0402001021	5/8	16,0	1/2-14	12,0	27	33
0402001023	5/8	16,0	5/8-14	12,0	30	34
0402001027	5/8	16,0	3/4-14	12,0	32	35
0402001221	3/4	19,0	1/2-14	15,0	25	34
0402001227	3/4	19,0	3/4-14	15,0	32	36
0402001233	3/4	19,0	1-11	15,0	41	39
0402001633	1	25,4	1-11	20,0	41	40
0402001642	1	25,4	1.1/4-11	20,0	50	44
0402002042	1.1/4	31,8	1.1/4-11	26,0	50	45
0402002048	1.1/4	31,8	1.1/2-11	26,0	55	46
0402002448	1.1/2	38,1	1.1/2-11	32,0	55	46
0402002451	1.1/2	38,1	2-11	32,0	70	53,5
0402003251	2	50,8	2-11	44,0	70	53,5

BSP ГАЙКА 60°КОНУС

DKR

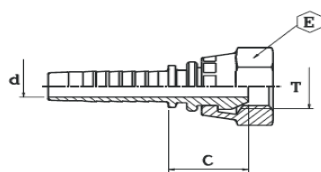

Код	Размер	рукава	Т (резьба)	d	E	C
	дюйм	мм				
0416200310	3/16	4,8	1/8-28	3,0	14	16
0416200313	3/16	4,8	1/4-19	3,0	19	18
0416200317	3/16	4,8	3/8-19	3,0	22	30
0416200410	1/4	6,4	1/8-28	4,0	14	16
0416200413	1/4	6,4	1/4-19	4,0	19	18
0416200417	1/4	6,4	3/8-19	4,0	22	20
0416200421	1/4	6,4	1/2-14	4,0	27	22
0416200513	5/16	8,0	1/4-19	5,5	19	18
0416200517	5/16	8,0	3/8-19	5,5	22	20
0416200521	5/16	8,0	1/2-14	5,5	27	22
0416200613	3/8	9,5	1/4-19	7,0	19	18
0416200617	3/8	9,5	3/8-19	7,0	22	20
0416200621	3/8	9,5	1/2-14	7,0	27	22
0416200817	1/2	12,7	3/8-19	9,5	22	20
0416200821	1/2	12,7	1/2-14	9,5	27	23
0416200823	1/2	12,7	5/8-14	9,5	30	23
0416200827	1/2	12,7	3/4-14	9,5	32	22
0416201021	5/8	16,0	1/2-14	12,0	27	23
0416201023	5/8	16,0	5/8-14	12,0	30	22
0416201027	5/8	16,0	3/4-14	12,0	32	22
0416201227	3/4	19,0	3/4-14	15,0	32	23
0416201233	3/4	19,0	1-11	15,0	38	25
0416201633	1	25,4	1-11	20,0	38	26
0416401642	1	25,4	1.1/4-11	20,0	50	30
0416402042	1.1/4	31,8	1.1/4-11	26,0	50	32
0416402048	1.1/4	31,8	1.1/2-11	26,0	55	34
0416402448	1.1/2	38,1	1.1/2-11	32,0	55	34
0416402451	1.1/2	38,1	2-11	32,0	70	31
0416403251	2	50,8	2-11	44,0	70	31

BSP 90° УГЛОВОЙ ФИТИНГ 60°КОНУС

DKR-90°

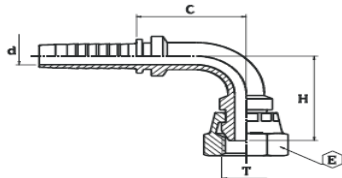

Код	Размер	рукава	Т (резьба)	d	E	H	C
	дюйм	мм					
0427200310	3/16	4,8	1/8-28	3,0	14	22	24
0427200313	3/16	4,8	1/4-19	3,0	19	22	26
0427200413	1/4	6,4	1/4-19	4,0	19	25	28
0427200417	1/4	6,4	3/8-19	4,0	22	25	31
0427200517	5/16	8,0	3/8-19	5,5	22	29	36
0427200617	3/8	9,5	3/8-19	7,0	22	33	34
0427200621	3/8	9,5	1/2-14	7,0	27	33	37
0427200817	1/2	12,7	3/8-19	9,5	22	39	39
0427200821	1/2	12,7	1/2-14	9,5	27	39	41
0427200823	1/2	12,7	5/8-14	9,5	30	39	41
0427200827	1/2	12,7	3/4-14	9,5	32	39	44
0427201023	5/8	16,0	5/8-14	12,0	30	45	47
0427201027	5/8	16,0	3/4-14	12,0	32	45	47
0427201227	3/4	19,0	3/4-14	15,0	32	56	54
0427201233	3/4	19,0	1-11	15,0	38	56	58
0427201633	1	25,4	1-11	20,0	38	70	66
0427402042	1.1/4	31,8	1.1/4-11	26,0	50	86	85
0427402448	1.1/2	38,1	1.1/2-11	32,0	55	100	99
0427403251	2	50,8	2-11	44,0	70	132	125

BSP 45° УГЛОВОЙ ФИТИНГ 60°КОНУС

DKR-45°

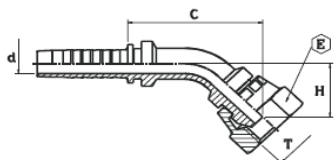

Код	Размер	рукава	Т (резьба)	d	E	H	C
	дюйм	мм					
0428200310	3/16	4,8	1/8-28	3,0	14	16	34
0428200313	3/16	4,8	1/4-19	3,0	19	17	37
0428200413	1/4	6,4	1/4-19	4,0	19	16	37
0428200417	1/4	6,4	3/8-19	4,0	22	18	39
0428200517	5/16	8,0	3/8-19	5,5	22	21	38
0428200617	3/8	9,5	3/8-19	7,0	22	19	44
0428200621	3/8	9,5	1/2-14	7,0	27	21	45
0428200821	1/2	12,7	1/2-14	9,5	27	24	53
0428200823	1/2	12,7	5/8-14	9,5	30	23	52
0428200827	1/2	12,7	3/4-14	9,5	32	25	54
0428201023	5/8	16,0	5/8-14	12,0	30	25	60
0428201027	5/8	16,0	3/4-14	12,0	32	25	60
0428201227	3/4	19,0	3/4-14	15,0	32	28	70
0428201233	3/4	19,0	1-11	15,0	38	31	72
0428201633	1	25,4	1-11	20,0	38	35	84
0428401642	1	31,8	1.1/4-11	20,0	50	37	86
0428402042	1.1/4	31,8	1.1/4-11	26,0	50	50	103
0428402448	1.1/2	38,1	1.1/2-11	32,0	55	55	116
0428403251	2	50,8	2-11	44,0	70	70	143

BSP 90° УГЛОВОЙ КОМПАКТНЫЙ ФИТИНГ 60°КОНУС

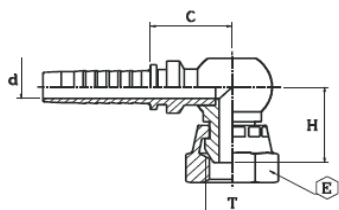

Код	Размер	рукава	Т (резьба)	d	E	H	C
	дюйм	мм					
0441200310	3/16	4,8	1/8-28	3,0	14	17	15
0441200413	1/4	6,4	1/4-19	4,0	19	21	25
0441200517	5/16	8,0	3/8-19	5,5	22	22	26
0441200617	3/8	9,5	3/8-19	7,0	22	22	26
0441200621	3/8	9,5	1/2-14	7,0	27	26	26
0441200821	1/2	12,7	1/2-14	9,5	27	27	27
0441201023	5/8	16,0	5/8-14	12,0	30	29	27
0441201227	3/4	19,0	3/4-14	15,0	32	29	31
0441201633	1	25,4	1-11	20,0	38	35	37

ЛС ШТУЦЕР 74°КОНУС AGJ

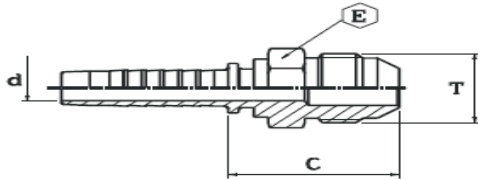

Код	Размер рукава		Т (резьба)	d	E	C
	дюйм	мм				
0402550311	3/16	4,8	7/16-20	3	12	26
0402550411	1/4	6,4	7/16-20	4	12	27
0402550412	1/4	6,4	1/2-20	4	14	27
0402550414	1/4	6,4	9/16-18	4	15	27
0402550514	5/16	8,0	9/16-18	5,5	15	27
0402550614	3/8	9,5	9/16-18	7	15	27
0402550613	3/8	9,5	5/8-18	7	17 * SAE 45o	27
0402550619	3/8	9,5	3/4-16	7	19	30
0402550622	3/8	9,5	7/8-14	7	24	34
0402550819	1/2	12,7	3/4-16	9,5	19	31
0402550822	1/2	12,7	7/8-14	9,5	24	35
0402550827	1/2	12,7	1.1/16-12	9,5	27	37
0402551022	5/8	16,0	7/8-14	12	24	35
0402551027	5/8	16,0	1.1/16-12	12	27	37
0402551222	3/4	19,0	7/8-14	15	24	36
0402551227	3/4	19,0	1.1/16-12	15	27	38
0402551230	3/4	19,0	1.3/16-12	15	32	41
0402551233	3/4	19,0	1.5/16-12	15	34	42
0402551627	1	25,4	1.1/16-12	20	27	39
0402551633	1	25,4	1.5/16-12	20	34	43
0402551641	1	25,4	1.5/8-12	20	42	46
0402552041	1.1/4	31,8	1.5/8-12	26	42	47
0402552048	1.1/4	31,8	1.7/8-12	26	50	52
0402552448	1.1/2	38,1	1.7/8-12	32	50	52
0402553252	2	50,8	2.1/2-12	44	65	62

ЛС ГАЙКА 74°КОНУС DKJ

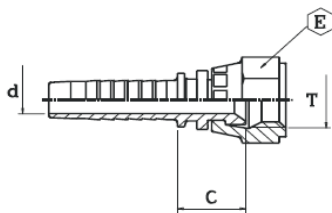

Код	Размер рукава		Т (резьба)	d	E	C
	дюйм	мм				
0416250311	3/16	4,8	7/16-20	3	15	13
0416250411	1/4	6,4	7/16-20	4	15	13
0416250412	1/4	6,4	1/2-20	4	17	15
0416250414	1/4	6,4	9/16-18	4	19	16
0416250512	5/16	8,0	1/2-20	5,5	17	15
0416250514	5/16	8,0	9/16-18	5,5	19	16
0416250614	3/8	9,5	9/16-18	7	19	16
0416250613	3/8	9,5	5/8-18	7	22*	15
0416250619	3/8	9,5	3/4-16	7	24	16
0416250819	1/2	12,7	3/4-16	9,5	24	17
0416250822	1/2	12,7	7/8-14	9,5	27	19
0416250827	1/2	12,7	1.1/16-12	9,5	32	19
0416251022	5/8	16,0	7/8-14	12	27	19
0416251027	5/8	16,0	1.1/16-12	12	32	19
0416251227	3/4	19,0	1.1/16-12	15	32	20
0416251230	3/4	19,0	1.3/16-12	15	36	21
0416251233	3/4	19,0	1.5/16-12	15	38	21
0416251633	1	25,4	1.5/16-12	20	38	22

ЛС 90° УГЛОВОЙ 74°КОНУС DKJ-90°

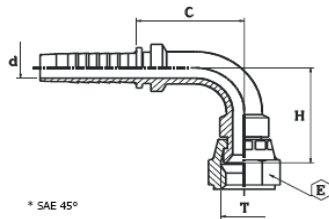

Код	Размер рукава		Т (резьба)	d	E	H	C
	дюйм	мм					
0427250311	3/16	4,8	7/16-20	3	15	22	22
0427250411	1/4	6,4	7/16-20	4	15	24	25
0427250412	1/4	6,4	1/2-20	4	17	25	25
0427250414	1/4	6,4	9/16-18	4	19	27	25
0427250514	5/16	8,0	9/16-18	5,5	19	33	29
0427250614	3/8	9,5	9/16-18	7	19	32	33
0427250613	3/8	9,5	5/8-18	7	22	32	33
0427250619	3/8	9,5	3/4-16	7	24	33	33
0427250819	1/2	12,7	3/4-16	9,5	24	38	39
0427250822	1/2	12,7	7/8-14	9,5	27	41	39
0427250827	1/2	12,7	1.1/16-12	9,5	32	42	39
0427251022	5/8	16,0	7/8-14	12	27	45	45
0427251027	5/8	16,0	1.1/16-12	12	32	45	45
0427251227	3/4	19,0	1.1/16-12	15	32	52	56
0427251230	3/4	19,0	1.3/16-12	15	36	53	56
0427251233	3/4	19,0	1.5/16-12	15	38	57	56
0427251633	1	25,4	1.5/16-12	20	38	65	70

ЛС 45° УГЛОВОЙ 74°КОНУС DKJ-45°

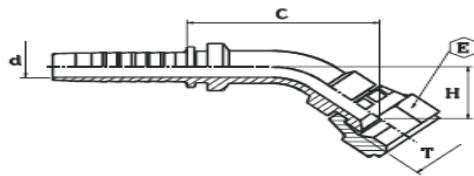

Код	Размер рукава		Т (резьба)	d	E	H	C
	дюйм	мм					
428250311	3/16	4,8	7/16-20	3	15	14	32
428250411	1/4	6,4	7/16-20	4	15	13	34
428250412	1/4	6,4	1/2-20	4	17	14	35
428250414	1/4	6,4	9/16-18	4	19	15	36
428250514	5/16	8,0	9/16-18	5,5	19	20	37
428250614	3/8	9,5	9/16-18	7	19	17	42
428250613	3/8	9,5	5/8-18	7	22	17	42
428250619	3/8	9,5	3/4-16	7	24	18	43
428250819	1/2	12,7	3/4-16	9,5	24	21	50
428250822	1/2	12,7	7/8-14	9,5	27	23	52
428250827	1/2	12,7	1.1/16-12	9,5	32	24	53
428251022	5/8	16,0	7/8-14	12	27	23	58
428251027	5/8	16,0	1.1/16-12	12	32	24	59
428251227	3/4	19,0	1.1/16-12	15	32	27	69
428251230	3/4	19,0	1.3/16-12	15	36	27	69
428251233	3/4	19,0	1.5/16-12	15	38	30	72
428251633	1	25,4	1.5/16-12	20	38	34	83

МЕТРИЧЕСКИЙ ШТУЦЕР 24°КОНУС

CEL DIN 3865

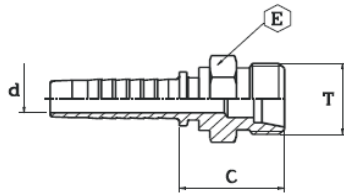

Код	Размер рукава		Т (резьба)	Посадочн D трубы	d	E	C
	дюйм	мм					
0405030312	3/16	4,8	M12-1.5	6	3	14	22
0405030412	1/4	6,4	M12-1.5	6	4	14	23
0405030414	1/4	6,4	M14-1.5	8	4	15	22
0405030416	1/4	6,4	M16-1.5	10	4	17	23
0405030418	1/4	6,4	M18-1.5	12	4	19	24
0405030516	5/16	8	M16-1.5	10	5,5	17	23
0405030518	5/16	8	M18-1.5	12	5,5	19	24
0405030616	3/8	9,5	M16-1.5	10	7	17	23
0405030618	3/8	9,5	M18-1.5	12	7	19	24
0405030622	3/8	9,5	M22-1.5	15	7	22	25
0405030818	1/2	12,7	M18-1.5	12	9,5	19	25
0405030822	1/2	12,7	M22-1.5	15	9,5	22	26
0405030826	1/2	12,7	M26-1.5	18	9,5	27	27
0405031026	5/8	16	M26-1.5	18	12	27	27
0405031226	3/4	19	M26-1.5	18	15	27	28
0405031230	3/4	19	M30-2	22	15	30	33
0405031636	1	25,4	M36-2	28	20	36	32
0405032045	1.1/4	31,8	M45-2	35	26	46	36
0405032452	1.1/2	38,1	M52-2	42	32	55	38

МЕТРИЧЕСКИЙ ШТУЦЕР 24°КОНУС

CES DIN 3865

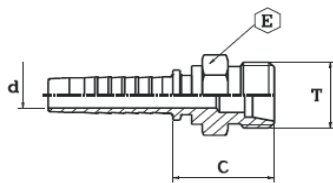

Код	Размер рукава		Т (резьба)	Посадочн D трубы	d	E	C
	дюйм	мм					
0406030316	3/16	4,8	M16-1.5	8	3	17	26
0406030416	1/4	6,4	M16-1.5	8	4	17	27
0406030418	1/4	6,4	M18-1.5	10	4	19	27
0406030420	1/4	6,4	M20-1.5	12	4	22	29
0406030520	5/16	8	M20-1.5	12	5,5	22	29
0406030618	3/8	9,5	M18-1.5	12	7	22	27
0406030620	3/8	9,5	M20-1.5	12	7	22	29
0406030622	3/8	9,5	M22-1.5	14	7	22	31
0406030624	3/8	9,5	M24-1.5	16	7	24	31
0406030824	1/2	12,7	M24-1.5	16	9,5	24	32
0406031030	5/8	16	M30-2	20	12	30	34
0406031230	3/4	19	M30-2	20	15	30	35
0406031236	3/4	19	M36-2	25	15	36	38
0406031636	1	25,4	M36-2	25	20	36	39
0406031642	1	25,4	M42-2	30	20	46	42
0406032042	1.1/4	31,8	M42-2	30	26	46	43
0406032052	1.1/4	31,8	M52-2	38	26	55	50
0406032452	1.1/2	38,1	M52-2	38	32	55	50

**МЕТРИЧЕСКАЯ ГАЙКА
24°КОНУС
DKOL DIN 3865**

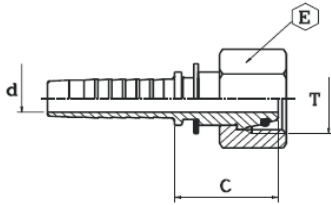

Код	Размер рукава		Т (резьба)	Посадоч D трубы	d	E	C
	дюйм	мм					
0422240312	3/16	4,8	M12-1.5	6	3	14	23
0422240412	1/4	6,4	M12-1.5	6	4	14	19
0422240414	1/4	6,4	M14-1.5	8	4	17	23
0422240416	1/4	6,4	M16-1.5	10	4	19	23
0422240418	1/4	6,4	M18-1.5	12	4	22	24
0422240516	5/16	8	M16-1.5	10	5,5	19	23
0422240616	3/8	9,5	M16-1.5	10	7	19	25
0422240618	3/8	9,5	M18-1.5	12	7	22	24
0422240622	3/8	9,5	M22-1.5	15	7	27	28
0422240822	1/2	12,7	M22-1.5	15	9,5	27	28
0422241026	5/8	16	M26-1.5	18	12	32	29
0422241027	5/8	16	M27-1.5	18	12	32	29
0422241230	3/4	19	M30-2	22	15	36	29
0422241636	1	25,4	M36-2	28	20	41	30
0422242045	1.1/4	31,8	M45-2	35	26	50	40
0422242452	1.1/2	38,1	M52-2	42	32	60	41

**90° МЕТРИЧЕСКИЙ
24°КОНУС
DKOL-90° DIN 3865**

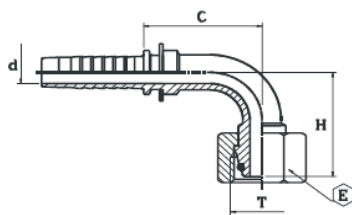

Код	Размер рукава		Т (резьба)	Посадоч D трубы	d	E	H	C
	дюйм	мм						
0434240312	3/16	4,8	M12-1.5	6	3	14	24	25
0434240414	1/4	6,4	M14-1.5	8	4	17	31	28
0434240416	1/4	6,4	M16-1.5	10	4	19	27	28
0434240418	1/4	6,4	M18-1.5	12	4	22	31	25
0434240516	5/16	8	M16-1.5	10	5,5	19	31	34
0434240616	3/8	9,5	M16-1.5	10	7	19	30	32
0434240618	3/8	9,5	M18-1.5	12	7	22	40	32
0434240622	3/8	9,5	M22-1.5	15	7	27	48	33
0434240822	1/2	12,7	M22-1.5	15	9,5	27	37	42
0434241026	5/8	16	M26-1.5	18	12	32	53	52
0434241027	5/8	16	M27-1.5	18	12	32	53	52
0434241226	3/4	19	M26-1.5	18	15	32	49	58
0434241230	3/4	19	M30-2	22	15	36	50	56
0434241636	1	25,4	M36-2	28	20	41	61	72
0434242045	1.1/4	31,8	M45-2	35	26	50	81	83
0434242452	1.1/2	38,1	M52-2	42	32	55	93	100

**45° МЕТРИЧЕСКИЙ
24°КОНУС
DKOL-45° DIN 3865**

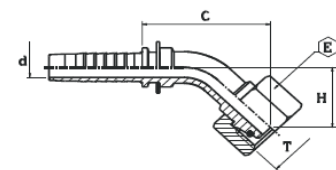

Код	Размер рукава		Т (резьба)	Посадоч D трубы	d	E	H	C
	дюйм	мм						
0436240312	3/16	4,8	M12-1.5	6	3	14	13	37
0436240414	1/4	6,4	M14-1.5	8	4	17	20	42
0436240416	1/4	6,4	M16-1.5	10	4	19	14	36
0436240418	1/4	6,4	M18-1.5	12	4	22	17	39
0436240516	5/16	8	M16-1.5	10	5,5	19	20	39
0436240618	3/8	9,5	M18-1.5	12	7	22	19	44
0436240622	3/8	9,5	M22-1.5	15	7	27	18	43
0436240822	1/2	12,7	M22-1.5	15	9,5	27	27	50
0436241026	5/8	16	M26-1.5	18	12	32	24	59
0436241226	5/8	16	M26-1.5	18	12	32	24	68
0436241227	5/8	16	M27-1.5	18	12	32	25	68
0436241230	3/4	19	M30-2	22	15	36	28	69
0436241636	1	25,4	M36-2	28	20	41	35	80
0436242045	1.1/4	31,8	M45-2	35	26	50	41	107
0436242452	1.1/2	38,1	M52-2	42	32	60	50	111

МЕТРИЧЕСКИЙ ШТУЦЕР 24°КОНУС

DKOS DIN 3865

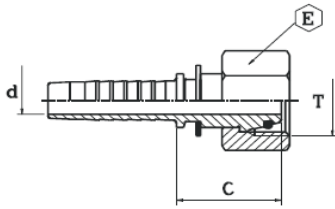

Код	Размер рукава		Т (резьба)	Посадоч D трубы	d	E	C
	дюйм	мм					
0423240316	3/16	4,8	M16-1.5	8	3	19	25
0423240416	1/4	6,4	M16-1.5	8	4	19	25
0423240418	1/4	6,4	M18-1.5	10	4	22	24
0423240518	5/16	8	M18-1.5	10	5,5	22	24
0423240520	5/16	8	M20-1.5	12	5,5	24	26
0423240618	3/8	9,5	M18-1.5	12	7	22	24
0423240620	3/8	9,5	M20-1.5	12	7	24	26
0423240622	3/8	9,5	M22-1.5	14	7	27	29
0423240824	1/2	12,7	M24-1.5	16	9,5	30	29
0423241030	5/8	16	M30-2	20	12	36	33
0423241230	3/4	19	M30-2	20	15	36	34
0423241236	3/4	19	M36-2	25	15	46	40
0423241636	1	25,4	M36-2	25	20	46	41
0423241642	1	25,4	M42-2	30	20	50	43
0423242052	1.1/4	31,8	M52-2	38	26	60	44
0423242452	1.1/2	38,1	M52-2	38	32	60	44

90° МЕТРИЧЕСКИЙ 24°КОНУС

DKOS-90° DIN 3865

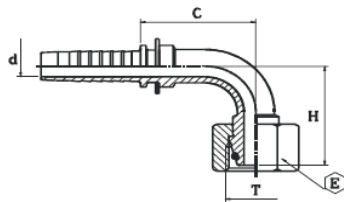

Код	Размер рукава		Т (резьба)	Посадоч D трубы	d	E	H	C
	дюйм	мм						
0438240316	3/16	4,8	M16-1.5	8	3	19	26	25
0438240416	1/4	6,4	M16-1.5	8	4	19	28	26
0438240418	1/4	6,4	M18-1.5	10	4	22	30	27
0438240520	5/16	8	M20-1.5	12	5,5	24	35	31
0438240618	3/8	9,5	M18-1.5	10	7	22	34	34
0438240620	3/8	9,5	M20-1.5	12	7	24	34	34
0438240622	3/8	9,5	M22-1.5	14	7	27	33	33
0438240824	1/2	12,7	M24-1.5	16	9,5	30	47	45
0438241030	5/8	16	M30-2	20	12	36	50	44
0438241230	3/4	19	M30-2	20	15	36	55	58
0438241236	3/4	19	M36-2	25	15	46	59	56
0438241636	1	25,4	M36-2	25	20	46	66	72
0438241642	1	25,4	M42-2	30	20	50	66	72
0438242052	1.1/4	31,8	M52-2	38	26	60	86	86
0438242452	1.1/2	38,1	M52-2	38	32	60	94	100

45° МЕТРИЧЕСКИЙ 24°КОНУС

DKOS-45° DIN 3865

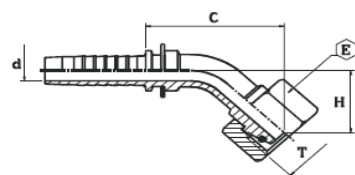

Код	Размер рукава		Т (резьба)	Посадоч D трубы	d	E	H	C
	дюйм	мм						
0440240316	3/16	4,8	M16-1.5	8	3	19	16	35
0440240416	1/4	6,4	M16-1.5	8	4	19	15	36
0440240418	1/4	6,4	M18-1.5	10	4	22	16	40
0440240518	5/16	8	M18-1.5	12	5,5	22	19	43
0440240520	5/16	8	M20-1.5	12	5,5	24	19	42
0440240620	3/8	9,5	M20-1.5	12	7	24	21	43
0440240622	3/8	9,5	M22-1.5	14	7	27	19	44
0440240824	1/2	12,7	M24-1.5	16	9,5	30	22	48
0440241030	5/8	16	M30-2	20	12	36	28	64
0440241230	3/4	19	M30-2	20	15	36	30	73
0440241236	3/4	19	M36-2	25	15	46	31	74
0440241636	1	25,4	M36-2	25	20	46	40	87
0440241642	1	25,4	M42-2	30	20	50	35	83
0440242052	1.1/4	31,8	M52-2	38	26	60	48	102
0440242452	1.1/2	38,1	M52-2	38	32	60	48	115

**МЕТРИЧЕСКАЯ ГАЙКА
24/60° КОНУС**

DKL DIN 3868

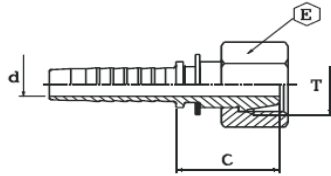

Код	Размер рукава	Т (резьба)	Посадоч D трубы	d	E	C	
	дюйм	мм	мм	мм	мм	мм	
0416640312	3/16	4,8	M12-1.5	6	3,0	14	19
0416640414	1/4	6,4	M14-1.5	8	4,0	17	19
0416640416	1/4	6,4	M16-1.5	10	4,0	19	19
0416640516	5/16	8,0	M16-1.5	10	5,5	19	19
0416640518	5/16	8,0	M18-1.5	12	5,5	22	21
0416640618	3/8	9,5	M18-1.5	12	7,0	22	21
0416640622	3/8	9,5	M22-1.5	15	7,0	27	22
0416640822	1/2	12,7	M22-1.5	15	9,5	27	22
0416641026	5/8	16,0	M26-1.5	18	12,0	32	24
0416641027	5/8	16,0	M27-1.5	18	12,0	32	24

**90° МЕТРИЧЕСКАЯ УГЛОВАЯ
24/60° КОНУС**

DKL-90° DIN 3868

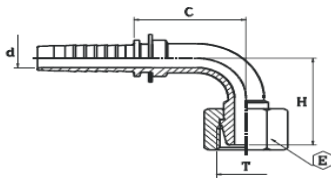

Код	Размер рукава	Т (резьба)	Посадоч D трубы	d	E	H	C	
	дюйм	мм	мм	мм	мм	мм	мм	
0427640414	1/4	6,4	M14-1.5	8	4,0	17	29	31
0427640416	1/4	6,4	M16-1.5	10	4,0	19	23	26
0427640516	5/16	8,0	M16-1.5	10	5,5	19	32	32
0427640618	3/8	9,5	M18-1.5	12	7,0	22	34	33
0427640622	3/8	9,5	M22-1.5	15	7,0	27	30	33
0427640822	1/2	12,7	M22-1.5	15	9,5	27	35	43
0427641026	5/8	16,0	M26-1.5	18	12,0	32	42	46
0427641027	5/8	16,0	M27-1.5	18	12,0	32	42	46

**45° МЕТРИЧЕСКАЯ УГЛОВАЯ
24/60° КОНУС**

DKL-45° DIN 3868

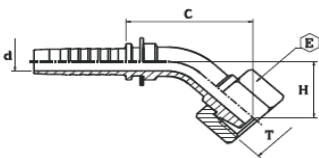

Код	Размер рукава	Т (резьба)	Посадоч D трубы	d	E	H	C	
	дюйм	мм	мм	мм	мм	мм	мм	
0428640414	1/4	6,4	M14-1.5	8	4,0	19	13	35
0428640416	1/4	6,4	M16-1.5	10	4,0	19	13	35
0428640516	5/16	8,0	M16-1.5	10	5,5	22	15	39
0428640618	3/8	9,5	M18-1.5	12	7,0	22	16	41
0428640822	1/2	12,7	M22-1.5	15	9,5	27	21	46

МЕТРИЧЕСКАЯ ГАЙКА 60°КОНУС

DKM DIN 3863

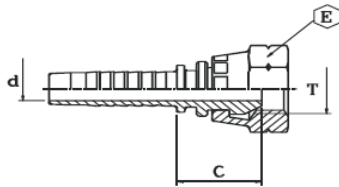

Код	Размер		T (резьба)	d	E	C
	дюйм	мм				
0416230310	3/16	4,8	M10-1	3,0	14	16
0416230312	3/16	4,8	M12-1.5	3,0	17	18
0416230412	1/4	6,4	M12-1.5	4,0	17	18
0416230414	1/4	6,4	M14-1.5	4,0	19	18
0416230416	1/4	6,4	M16-1.5	4,0	22	20
0416230418	1/4	6,4	M18-1.5	4,0	24	20
0416230514	5/16	8,0	M14-1.5	5,5	19	18
0416230516	5/16	8,0	M16-1.5	5,5	22	20
0416230518	5/16	8,0	M18-1.5	5,5	24	20
0416230614	3/8	9,5	M14-1.5	7,0	19	18
0416230616	3/8	9,5	M16-1.5	7,0	22	20
0416230618	3/8	9,5	M18-1.5	7,0	24	20
0416230620	3/8	9,5	M20-1.5	7,0	25	22
0416230622	3/8	9,5	M22-1.5	7,0	27	22
0416230816	1/2	12,7	M16-1.5	9,5	22	20
0416230818	1/2	12,7	M18-1.5	9,5	24	20
0416230822	1/2	12,7	M22-1.5	9,5	27	23
0416230826	1/2	12,7	M26-1.5	9,5	32	22
0416231026	5/8	16,0	M26-1.5	12,0	32	22
0416231226	3/4	19,0	M26-1.5	15,0	32	23
0416231230	3/4	19,0	M30-1.5	15,0	36	24
* 0416431638	1	25,4	M38-1.5	20,0	46	31
* 0416431638	1.1/4	31,8	M45-1.5	26,0	55	37

90° МЕТРИЧЕСКАЯ УГЛОВАЯ 60°КОНУС

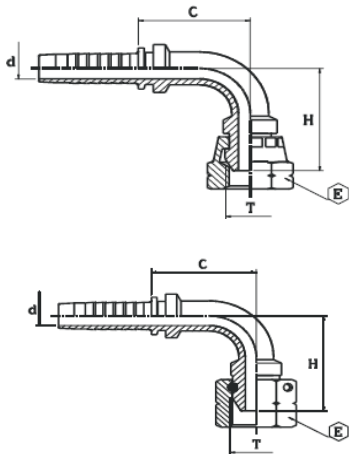

Код	Размер		T (резьба)	d	E	H	C
	дюйм	мм					
0427230310	3/16	4,8	M10-1	3,0	14	24	22
0427230312	3/16	4,8	M12-1.5	3,0	17	25	22
0427230412	1/4	6,4	M12-1.5	4,0	17	28	25
0427230414	1/4	6,4	M14-1.5	4,0	19	28	25
0427230416	1/4	6,4	M16-1.5	4,0	22	31	25
0427230516	5/16	8,0	M16-1.5	5,5	22	36	29
0427230518	5/16	8,0	M18-1.5	5,5	24	35	29
0427230614	3/8	9,5	M14-1.5	7,0	19	31	33
0427230616	3/8	9,5	M16-1.5	7,0	22	34	33
0427230618	3/8	9,5	M18-1.5	7,0	24	34	33
0427230818	1/2	12,7	M18-1.5	9,5	24	39	39
0427230822	1/2	12,7	M22-1.5	9,5	27	41	39
0427231026	5/8	16,0	M26-1.5	12,0	32	47	45
0427231226	3/4	19,0	M26-1.5	15,0	32	54	56
0427231230	3/4	19,0	M30-1.5	15,0	36	55	56
* 0427431638	1	25,4	M38-1.5	20,0	46	78	70

45° МЕТРИЧЕСКАЯ УГЛОВАЯ 60° КОНУС

DKM-45° DIN 3863

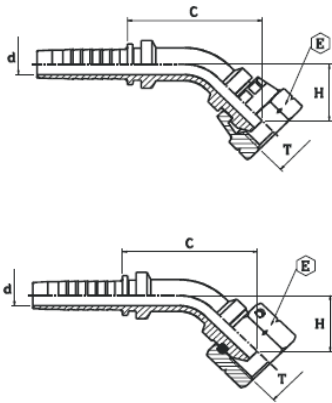

Код	Размер		T (резьба)	d	E	H	C
	дюйм	мм					
0428230310	3/16	4,8	M10-1	3,0	14	16	33
0428230312	3/16	4,8	M12-1.5	3,0	17	17	34
0428230412	1/4	6,4	M12-1.5	4,0	17	16	36
0428230414	1/4	6,4	M14-1.5	4,0	19	16	36
0428230416	1/4	6,4	M16-1.5	4,0	22	18	38
0428230516	5/16	8,0	M16-1.5	5,5	22	21	37
0428230518	5/16	8,0	M18-1.5	5,5	24	21	37
0428230614	3/8	9,5	M14-1.5	7,0	19	17	41
0428230616	3/8	9,5	M16-1.5	7,0	22	19	43
0428230618	3/8	9,5	M18-1.5	7,0	24	19	43
0428230818	1/2	12,7	M18-1.5	9,5	24	22	51
0428230822	1/2	12,7	M22-1.5	9,5	27	24	52
0428231026	5/8	16,0	M26-1.5	12,0	32	25	59
0428231226	3/4	19,0	M26-1.5	15,0	32	28	69
0428231230	3/4	19,0	M30-1.5	15,0	36	29	70
*0428431638	1	25,4	M38-1.5	20,0	46	42	87

JIS KOMATSU ВНУТР. КОНУС 60°

PFMJM

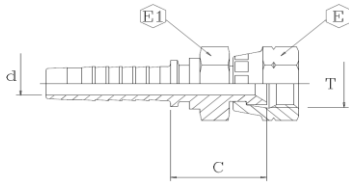

Код	Размер		T (резьба)	E	E1	C
	дюйм	мм				
0416280414	1/4	6,4	M14-1,5	19	19	21,5
0416280516	5/16	8,0	M16-1,5	22	19	22,5
0416280614	3/8	9,5	M14-1,5	19	19	22,0
0416280618	3/8	9,5	M18-1,5	24	22	25,5
0416280822	1/2	12,7	M22-1,5	27	27	25,5
0416280824	1/2	12,7	M24-1,5	30	27	25,5
0416281024	5/8	16,0	M24-1,5	30	30	25,5
0416281230	3/4	19,0	M30-1,5	36	36	31,5
0416281633	1	25,4	M33-1,5	41	36	34,5
0416282036	1.1/4	31,8	M36-1,5	46	46	38,0
0416282442	1.1/2	38,1	M42-1,5	50	50	41,5

JIS BSP ГАЙКА внутренний конус 60°

PFMJG

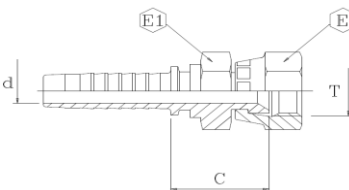

Код	Размер		T (резьба)	E	E1	C
	дюйм	мм				
0416270413	1/4	6,4	1/4-19	19	19	19,5
0416270617	3/8	9,5	3/8-19	22	19	23,0
0416270821	1/2	12,7	1/2-14	27	27	26,0
0416271227	3/4	19,0	3/4-14	32	32	28,5
0416271633	1	25,4	1-11	38	36	31,0

**СОЕДИНЕНИЕ ПОД ВРЕЗНОЕ
КОЛЬЦО С ГАЙКОЙ
BEL-BES DIN 2353**

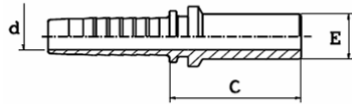

Код	Размер	рукава	Е труба	d	тип	C
	дюйм	мм	мм	мм		
0443000406	1/4	6,4	6	4,0	L/S	32
0443000408	1/4	6,4	8	4,0	L/S	29
0443000410	1/4	6,4	10	4,0	L/S	32
0443000412	1/4	6,4	12	4,0	L/S	30
0443000508	5/16	8,0	8	5,5	L/S	29
0443000510	5/16	8,0	10	5,5	L/S	30
0443000512	5/16	8,0	12	5,5	L/S	32
0443000610	3/8	9,5	10	7,0	L/S	31
0443000612	3/8	9,5	12	7,0	L/S	31
0443000614	3/8	9,5	14	7,0	S	36
0443000615	3/8	9,5	15	7,0	L	32
0443000814	1/2	12,7	14	9,5	S	37
0443000815	1/2	12,7	15	9,5	L	33
0443000816	1/2	12,7	16	9,5	S	38
0443000818	1/2	12,7	18	9,5	L	34
0443001018	5/8	16,0	18	12,0	L	34
0443001020	5/8	16,0	20	12,0	S	44
0443001022	5/8	16,0	22	12,0	L	36
0443001218	3/4	19,0	18	15,0	L	34
0443001220	3/4	19,0	20	15,0	S	45
0443001222	3/4	19,0	22	15,0	L	36
0443001225	3/4	19,0	25	15,0	S	49
0443001625	1	25,4	25	20,0	S	49
0443001628	1	25,4	28	20,0	L	39
0443001630	1	25,4	30	20,0	S	54
0443002030	1.1/4	31,8	30	26,0	S	55
0443002035	1.1/4	31,8	35	26,0	L	47
0443002038	1.1/4	31,8	38	26,0	S	61
0443002438	1.1/2	38,1	38	32,0	S	61
0443002442	1.1/2	38,1	42	32,0	L	49

**УГЛОВОЕ СОЕДИНЕНИЕ ПОД
ВРЕЗНОЕ КОЛЬЦО С ГАЙКОЙ
BEL-BES-90 DIN 2353**

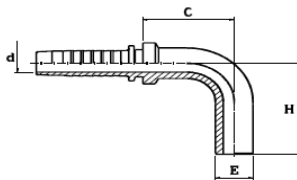
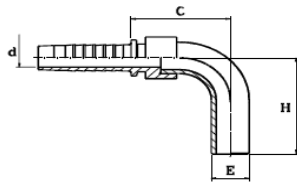

Код	Размер	рукава	Е труба	d	тип	H	C
	дюйм	мм	мм	мм			
0444000406	1/4	6,4	6	4,0	L/S	35	25
0444000408	1/4	6,4	8	4,0	L/S	34	25
0444000410	1/4	6,4	10	4,0	L/S	37	25
0444000412	1/4	6,4	12	4,0	L/S	37	25
0444000510	5/16	8,0	10	5,5	L/S	40	29
0444000512	5/16	8,0	12	5,5	L/S	42	29
0444000610	3/8	9,5	10	7,0	L/S	40	30
0444000612	3/8	9,5	12	7,0	L/S	40	30
0444000614	3/8	9,5	14	7,0	S	45	33
0444000615	3/8	9,5	15	7,0	L	53	38
0444000814	1/2	12,7	14	9,5	S	49	34
0444000815	1/2	12,7	15	9,5	L	53	39
0444000816	1/2	12,7	16	9,5	S	56	42
0444000818	1/2	12,7	18	9,5	L	56	42
0444001018	5/8	16,0	18	12,0	L	56	42
0444001020	5/8	16,0	20	12,0	S	65	47
0444001022	5/8	16,0	22	12,0	L	70	53
0444001220	3/4	19,0	20	15,0	S	65	48
0444001222	3/4	19,0	22	15,0	L	70	53
0444001225	3/4	19,0	25	15,0	S	75	56
0444001625	1	25,4	25	20,0	S	75	60
0444001628	1	25,4	28	20,0	L	83	67
0444001630	1	25,4	30	20,0	S	88	68
0444002030	1.1/4	31,8	30	26,0	S	88	67
0444002035	1.1/4	31,8	35	26,0	L	96	77
0444002038	1.1/4	31,8	38	26,0	S	105	81
0444002438	1.1/2	38,1	38	32,0	S	105	81
0444002442	1.1/2	38,1	42	32,0	L	115	91

**УГЛОВОЕ СОЕДИНЕНИЕ ПОД
ВРЕЗНОЕ КОЛЬЦО С ГАЙКОЙ
BEL-BES-45 DIN 2353**

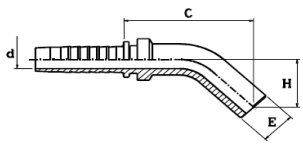
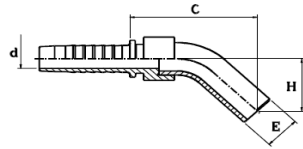

Код	Размер	рукава	Е	d	тип	Н	С
	дюйм	мм	мм	мм			
0445000306	3/16	4,8	6	3,0	L/S	20	41
0445000308	3/16	4,8	8	3,0	L/S	23	44
0445000406	1/4	6,4	6	4,0	L/S	30	42
0445000408	1/4	6,4	8	4,0	L/S	29	41
0445000410	1/4	6,4	10	4,0	L/S	30	42
0445000412	1/4	6,4	12	4,0	L/S	30	42
0445000510	5/16	8,0	10	5,5	L/S	25	50
0445000512	5/16	8,0	12	5,5	L/S	26	53
0445000610	3/8	9,5	10	7,0	L/S	34	51
0445000612	3/8	9,5	12	7,0	L/S	34	54
0445000614	3/8	9,5	14	7,0	S	27	51
0445000615	3/8	9,5	15	7,0	L	28	55
0445000814	1/2	12,7	14	9,5	S	27	52
0445000815	1/2	12,7	15	9,5	L	28	56
0445000816	1/2	12,7	16	9,5	S	28	55
0445000818	1/2	12,7	18	9,5	L	31	59
0445001018	5/8	16,0	18	12,0	L	31	59
0445001020	5/8	16,0	20	12,0	S	33	65
0445001022	5/8	16,0	22	12,0	L	35	68
0445001220	3/4	19,0	20	15,0	S	33	66
0445001222	3/4	19,0	22	15,0	L	35	67
0445001225	3/4	19,0	25	15,0	S	39	77
0445001625	1	25,4	25	20,0	S	39	81
0445001628	1	25,4	28	20,0	L	38	92
0445001630	1	25,4	30	20,0	S	44	91
0445002030	1.1/4	31,8	30	26,0	S	44	91
0445002035	1.1/4	31,8	35	26,0	L	46	97
0445002038	1.1/4	31,8	38	26,0	S	51	103
0445002438	1.1/2	38,1	38	32,0	S	51	103
0445002442	1.1/2	38,1	42	32,0	L	92	113

Тип L - BEL (лёгкая серия), тип S - BES (тяжёлая серия)

**РЕМОНТНЫЙ ФИТИНГ
PFRGZ**

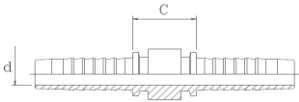

Код	Размер	рукава	d	C
	дюйм	мм	мм	мм
0490000303	3/16	4,8	3	17
0490000404	1/4	6,4	4	17
0490000505	5/16	8	5,5	17
0490000606	3/8	9,5	7	17
0490000808	1/2	12,7	9,5	18
0490001010	5/8	16	12	18
0490001212	3/4	19	15	19
0490001616	1	25,4	20	21
0490002020	1.1/4	31,8	26	24

**МЕТРИЧЕСКИЙ
ШТУЦЕР 60° КОНУС
AGM DIN 3863**

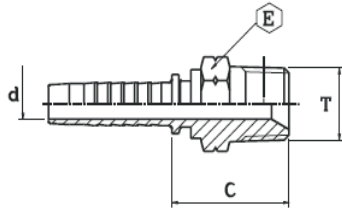

Код	Размер	рукава	Т (резьба)	d	E	C
	дюйм	мм		мм	мм	мм
0402130312	3/16	4,8	M12-1,5	3,0	17	25
0402130412	1/4	6,4	M12-1,5	4,0	17	26
0402130414	1/4	6,4	M14-1,5	4,0	19	26
0402130416	1/4	6,4	M16-1,5	4,0	22	26
0402130516	5/16	8,0	M16-1,5	5,5	22	26
0402130518	5/16	8,0	M18-1,5	5,5	24	27
0402130614	3/8	9,5	M14-1,5	7,0	19	26
0402130616	3/8	9,5	M16-1,5	7,0	22	26
0402130618	3/8	9,5	M18-1,5	7,0	24	27
0402130818	1/2	12,7	M18-1,5	9,5	24	28
0402130822	1/2	12,7	M22-1,5	9,5	27	30
0402131026	5/8	16,0	M26-1,5	12,0	32	32
0402131226	3/4	19,0	M26-1,5	15,0	32	33
0402131230	3/4	19,0	M30-1,5	15,0	36	36
0402131638	1	25,4	M38-1,5	20,0	46	37
0402132045	1.1/4	31,8	M45-1,5	26,0	55	39
0402131638	1	25,4	M38-1,5	20,0	46	37
0402132045	1.1/4	31,8	M45-1,5	26,0	55	39

**NPTF ШТУЦЕР
60° КОНУС
AGN**

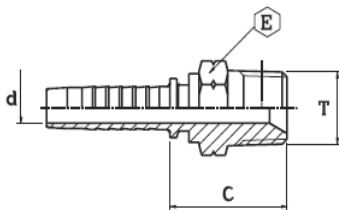

Код	Размер	рукава	Т (резьба)	d	E	C
	дюйм	мм		мм	мм	мм
0402020310	3/16	4,8	1/8-27	3,0	12	22
0402020313	3/16	4,8	1/4-18	3,0	15	28
0402020410	1/4	6,4	1/8-27	4,0	12	22
0402020413	1/4	6,4	1/4-18	4,0	15	28
0402020417	1/4	6,4	3/8-18	4,0	19	28
0402020513	5/16	8,0	1/4-18	5,5	15	28
0402020517	5/16	8,0	3/8-18	5,5	19	28
0402020613	3/8	9,5	1/4-18	7,0	15	28
0402020617	3/8	9,5	3/8-18	7,0	19	28
0402020621	3/8	9,5	1/2-14	7,0	22	34
0402020817	1/2	12,7	3/8-18	9,5	19	29
0402020821	1/2	12,7	1/2-14	9,5	22	35
0402021021	5/8	16,0	1/2-14	12,0	22	35
0402021027	5/8	16,0	3/4-14	12,0	27	36
0402021227	3/4	19,0	3/4-14	15,0	27	37
0402021233	3/4	19,0	1-11.1/2	15,0	36	43
0402021633	1	25,4	1-11.1/2	20,0	36	44
0402021642	1	25,4	1.1/4-11.1/2	20,0	46	46
0402022042	1.1/4	31,8	1.1/4-11.1/2	26,0	46	47
0402022448	1.1/2	38,1	1.1/2-11.1/2	32,0	50	49
0402023251	2	50,8	2-11.1/2	44,0	65	55

BSP BANJO RNR

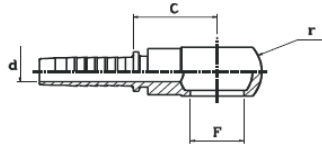

Код	Размер	рукава	F	D	r	C
	дюйм	мм	отверстие	трубы	мм	мм
0450000310	3/16	4,8	1/8-28	3	17	19
0450000313	3/16	4,8	1/4-19	3	24	26
0450000410	1/4	6,4	1/8-28	4	17	20
0450000413	1/4	6,4	1/4-19	4	24	26
0450000417	1/4	6,4	3/8-19	4	28	26
0450000513	5/16	8,0	1/4-19	6	24	26
0450000517	5/16	8,0	3/8-19	6	28	26
0450000613	3/8	9,5	1/4-19	7	24	29
0450000617	3/8	9,5	3/8-19	7	28	26
0450000621	3/8	9,5	1/2-14	7	36	31
0450000817	1/2	12,7	3/8-19	10	28	27
0450000821	1/2	12,7	1/2-14	10	36	31
0450000827	1/2	12,7	3/4-14	10	45	38
0450001023	5/8	16,0	5/8-14	12	40	38
0450001227	3/4	19,0	3/4-14	15	45	38
0450001233	3/4	19,0	1-11	15	58	50
0450001633	1	25,4	1-11	20	58	51
0405032045	1.1/4	31,8	1.1/4	35	26	36

МЕТРИЧЕСКОЕ BANJO RNM

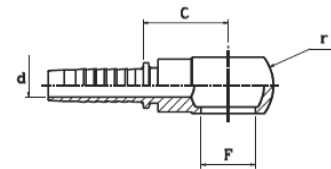

Код	Размер	рукава	F	D	r	C
	дюйм	мм	отверстие	трубы	мм	мм
0450030308	3/16	4,8	M 8-1	3,0	14	21
0450030310	3/16	4,8	M10-1	3,0	17	19
0450030410	1/4	6,4	M10-1	4,0	17	25
0450030412	1/4	6,4	M12-1.5	4,0	20	27
0450030414	1/4	6,4	M14-1.5	4,0	24	27
0450030512	5/16	8,0	M12-1.5	5,5	20	22
0450030514	5/16	8,0	M14-1.5	5,5	24	28
0450030516	5/16	8,0	M16-1.5	5,5	28	26
0450030518	5/16	8,0	M18-1.5	5,5	32	29
0450030614	3/8	9,5	M14-1.5	7,0	24	25
0450030616	3/8	9,5	M16-1.5	7,0	28	26
0450030618	3/8	9,5	M18-1.5	7,0	32	29
0450030818	1/2	12,7	M18-1.5	9,5	32	29
0450030822	1/2	12,7	M22-1.5	9,5	36	31
0450031022	5/8	16,0	M22-1.5	12,0	36	31
0450031226	3/4	19,0	M26-1.5	15,0	46	38
0450031630	1	25,4	M30-1.5	20,0	54	43
0405032045	1.1/4	31,8	M45-2	42,5	35	26

BSP БОЛТ BFG

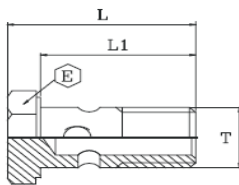

Код	T	L	L1	E	P
	дюйм	мм	мм	мм	max
1555013312	1/4-19	34,5	28,5	19,0	300
1555017400	3/8-19	40,5	33	22,0	300
1555021460	1/2-14	46,0	38	27,0	250
1555023500	5/8-14	50,0	42	30,0	200
1555027690	3/4-14	56,0	47	32,0	200
1555033860	1-11	69,0	58	41,0	150

МЕТРИЧЕСКИЙ БОЛТ BFM

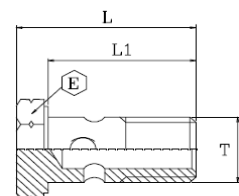

Код	T	L	L1	E	P
	дюйм	мм	мм	мм	max
1555110250	M10X1	24,0	19,5	14,0	300
1555112312	M12X1.5	31,5	25,5	17,0	300
1555114330	M14X1.5	34,0	28,5	19,0	300
1555116400	M16X1.5	41,0	33	22,0	300
1555118440	M18X1.5	44,5	36,5	24,0	250
1555122460	M22X1.5	46,5	38,5	27,0	200
1555126560	M26X1.5	56,0	45,5	32,0	200
1555130560	M30X1.5	66,0	55	36,0	150

ORFS ГАЙКА СО СТОПОРНОЙ ШАЙбой ORFS

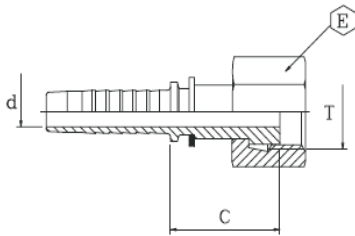

Код	Размер рукава		Т (резьба)	d	E	C
	дюйм	мм				
0486000414	1/4	6,4	9/16-18	4	19	24
0486000417	1/4	6,4	11/16-16	4	22	24
0486000517	5/16	8	11/16-16	5,5	22	24
0486000617	3/8	9,5	11/16-16	7	22	24
0486000621	3/8	9,5	13/16-16	7	24	30
0486000821	1/2	12,7	13/16-16	9,5	24	30
0486000825	1/2	12,7	1-14	9,5	30	33
0486000830	1/2	12,7	1.3/16-12	9,5	36	33
0486001025	5/8	16	1-14	12	30	33
0486001225	3/4	19	1-14	15	30	33
0486001230	3/4	19	1.3/16-12	15	36	34
0486001234	3/4	19	1.7/16-12	15	41	36
0486001634	1	25,4	1.7/16-12	20	41	37
0486002042	1.1/4	31,8	1.11/16-12	26	50	40
0486002452	1.1/2	38,1	2-12	32	60	41

ORFS 90° УГЛОВОЙ ORFS-90°

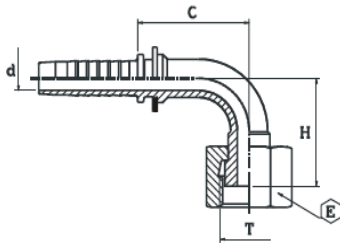

Код	Размер рукава		Т (резьба)	d	E	H	C
	дюйм	мм					
0485030414	1/4	6,4	9/16-18	4	19	24	27
0485030417	1/4	6,4	11/16-16	4	22	26	27
0485030617	3/8	9,5	11/16-16	7	22	29	34
0485030621	3/8	9,5	13/16-16	7	24	31	34
0485030821	1/2	12,7	13/16-16	9,5	24	36	42
0485030830	1/2	12,7	1.3/16-12	9,5	36	37	42
0485031025	5/8	16	1-14	12	30	40	46
0485031230	3/4	19	1.3/16-12	15	36	47	57
0485031634	1	25,4	1.7/16-12	20	41	58	72
0485032042	1.1/4	31,8	1.11/16-12	26	50	74	83
0485032452	1.1/2	38,1	2-12	32	70	85	100

ORFS 45° УГЛОВОЙ ORFS-45°

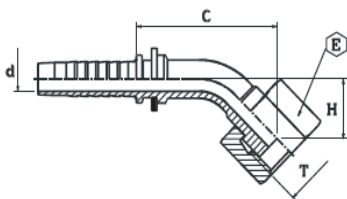

Код	Размер рукава		Т (резьба)	d	E	H	C
	дюйм	мм					
0485060414	1/4	6,4	9/16-18	4	19	12	34
0485060417	1/4	6,4	11/16-16	4	22	14	36
0485060617	3/8	9,5	11/16-16	7	22	16	41
0485060621	3/8	9,5	13/16-16	7	24	17	42
0485060821	1/2	12,7	13/16-16	9,5	24	21	47
0485060825	1/2	12,7	1-14	9,5	30	21	46
0485061025	5/8	16	1-14	12	30	21	57
0485061230	3/4	19	1.3/16-1	15	36	23	66
0485061634	1	25,4	21.7/16-12	20	41	27	77
0485062042	1.1/4	31,8	1.11/16-12	26	50	42	96
0485062452	1.1/2	38,1	2-12	32	70	44	107

ПРЯМОЙ ФЛАНЕЦ SAE 3000

SFL3

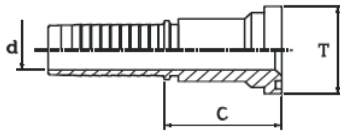

Код	Размер рукава	Размер фланца	d	C		
	дюйм	мм	T, "	T, мм	мм	мм
0454060821	1/2	12,7	1/2	30,2	9,5	45
0454060827	1/2	12,7	3/4	38,1	9,5	50
0454061227	3/4	19,0	3/4	38,1	15	50
0454061233	3/4	19,0	1	44,5	15	53
0454061633	1	25,4	1	44,5	20	54
0454061642	1	25,4	1.1/4	50,8	20	57
0454062042	1.1/4	31,8	1.1/4	50,8	26	59
0454062048	1.1/4	31,8	1.1/2	60,4	26	62
0454062448	1.1/2	38,1	1.1/2	60,4	32	62
0454062451	1.1/2	38,1	2	71,4	32	67
0454063251	2	50,8	2	71,4	44	68
0454063263	2	50,8	2.1/2	84,1	44	70
0454064063	2.1/2	63,0	2.1/2	84,1	55	76

90° ФЛАНЕЦ SAE 3000

90SFL3

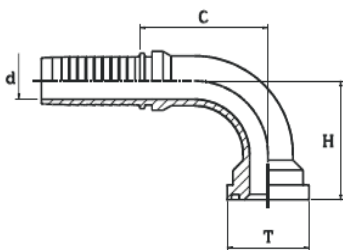

Код	Размер рукава	Размер фланца	d	H	C		
	дюйм	мм	T, "	T, мм	мм	мм	
0455060821	1/2	12,7	1/2	30,2	9,5	39	39
0455060827	1/2	12,7	3/4	38,1	9,5	44	39
0455061227	3/4	19,0	3/4	38,1	15	53	56
0455061233	3/4	19,0	1	44,5	15	58	56
0455061633	1	25,4	1	44,5	20	65	70
0455061642	1	25,4	1.1/4	50,8	20	70	70
0455062042	1.1/4	31,8	1.1/4	50,8	26	81	85
0455062048	1.1/4	31,8	1.1/2	60,4	26	85	85
0455062448	1.1/2	38,1	1.1/2	60,4	32	92	99
0455062451	1.1/2	38,1	2	71,4	32	95	99
0455063251	2	50,8	2	71,4	44	115	125
0455063263	2	50,8	2.1/2	84,1	44	120	125
*0456064063	2.1/2	63,1	2.1/2	84,1	55	95	99
*0456064876	3	75,5	3	101,6	68	114	123

45° ФЛАНЕЦ SAE 3000

45SFL3

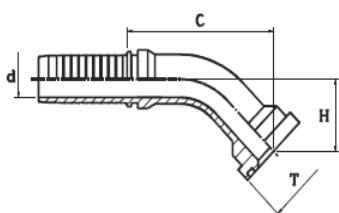

Код	Размер рукава	Размер фланца	d	H	C		
	дюйм	мм	T, "	T, мм	мм	мм	
0457060821	1/2	12,7	1/2	30,2	9,5	22	51
0457060827	1/2	12,7	3/4	38,1	9,5	25	54
0457061227	3/4	19,0	3/4	38,1	15	27	69
0457061233	3/4	19,0	1	44,5	15	31	73
0457061633	1	25,4	1	44,5	20	33	82
0457061642	1	25,4	1.1/4	50,8	20	37	86
0457062042	1.1/4	31,8	1.1/4	50,8	26	47	100
0457062048	1.1/4	31,8	1.1/2	60,4	26	49	102
0457062448	1.1/2	38,1	1.1/2	60,4	32	50	111
0457062451	1.1/2	38,1	2	71,4	32	52	113
0457063251	2	50,8	2	71,4	44	56	129
*0458064063	2.1/2	63,1	2.1/2	84,1	55	36	90
*0458064876	3	75,5	3	101,6	68	41	108

ПРЯМОЙ ФЛАНЕЦ SAE 6000
SFL6

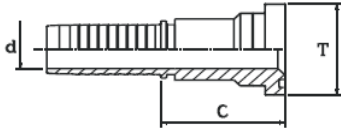

Код	Размер рукава	Размер фланца	d	C
	дюйм	мм	T, "	T, мм
0465060821	1/2	12,7	1/2	31,7
0465060827	1/2	12,7	3/4	41,3
0465061227	3/4	19,0	3/4	41,3
0465061233	3/4	19,0	1	47,6
0465061633	1	25,4	1	47,6
0465061642	1	25,4	1.1/4	54,0
0465062042	1.1/4	31,8	1.1/4	54,0
0465062048	1.1/4	31,8	1.1/2	63,5
0465062448	1.1/2	38,1	1.1/2	63,5
0465062451	1.1/2	38,1	2	79,4
0465063251	2	50,8	2	79,4

90° ФЛАНЕЦ SAE 6000
90SFL6

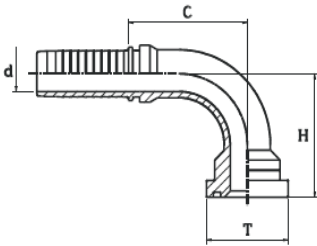

Код	Размер рукава	Размер фланца	d	H	C
	дюйм	мм	T, "	T, мм	мм
0467060821	1/2	12,7	1/2	31,7	9,5
0467060827	1/2	12,7	3/4	41,3	9,5
0467061227	3/4	19,0	3/4	41,3	15,0
0467061233	3/4	19,0	1	47,6	15,0
0467061633	1	25,4	1	47,6	20,0
0467061642	1	25,4	1.1/4	54,0	20,0
0467062042	1.1/4	31,8	1.1/4	54,0	26,0
0467062048	1.1/4	31,8	1.1/2	63,5	26,0
0467062448	1.1/2	38,1	1.1/2	63,5	32,0
0467062451	1.1/2	38,1	2	79,4	32,0
0467063251	2	50,8	2	79,4	44,0

45° ФЛАНЕЦ SAE 6000
45SFL6

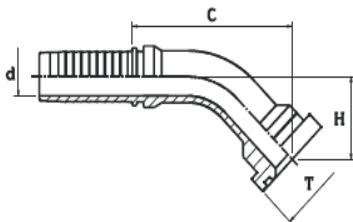

Код	Размер рукава	Размер фланца	d	H	C
	дюйм	мм	T, "	T, мм	мм
0469060821	1/2	12,7	1/2	31,7	9,5
0469060827	1/2	12,7	3/4	41,3	9,5
0469061227	3/4	19,0	3/4	41,3	15,0
0469061233	3/4	19,0	1	47,6	15,0
0469061633	1	25,4	1	47,6	20,0
0469061642	1	25,4	1.1/4	54,0	20,0
0469062042	1.1/4	31,8	1.1/4	54,0	26,0
0469062048	1.1/4	31,8	1.1/2	63,5	26,0
0469062448	1.1/2	38,1	1.1/2	63,5	32,0
0469062451	1.1/2	38,1	2	79,4	32,0
0469063251	2	50,8	2	79,4	44,0

**ПОЛУСКОБА ДЛЯ
ФЛАНЦА 3000 P.S.I.
AFS 3**

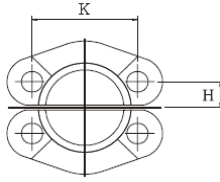

Код	D фланца		К	Н
	дюйм	мм		
2237802121	1/2"	30,2	38,1	8,74
2237802727	3/4"	38,1	47,63	11,13
2237803333	1 "	44,5	52,37	13,08
2237804242	1.1/4"	50,8	58,72	15,09
2237804848	1.1/2"	60,4	69,85	17,86
2237805151	2 "	71,5	77,77	21,44
2237805555	2.1/2"	84,1	88,9	25,4
2237806565	3 "	101,6	106,38	30,96
2237807070	3.1/2"	114,3	120,65	34,92
2237808080	4 "	127	130,18	38,88

**ПОЛУСКОБА ДЛЯ
ФЛАНЦА 6000 P.S.I.
AFS 6**

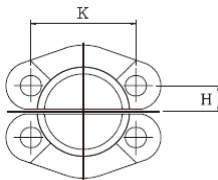

Код	D фланца		К	Н
	дюйм	мм		
2237902121	1/2"	31,8	40,49	9,12
2237902727	3/4"	41,3	50,8	11,91
2237903333	1 "	47,6	57,15	13,89
2237904242	1.1/4"	54	66,68	15,88
2237904848	1.1/2"	63,5	79,38	18,26
2237905151	2 "	79,4	96,82	22,23

**МЕТРИЧЕСКАЯ ГАЙКА
60°КОНУС
KÄRHER**

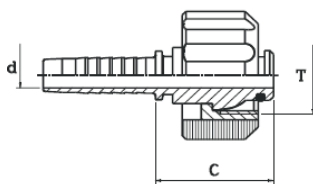

Код	Размер	рукава	Т (резьба)	d	C
				дюйм	мм
Тип К- нормальная гайка					
0408000422	1/4	6,4	M22-1.5	4,0	30,7
0408000522	5/16	7,9	M22-1.5	5,5	30,7
0408000622	3/8	9,5	M22-1.5 WAPP	7,0	30,7
Тип KL -длинная гайка					
0408020422	1/4	6,4	M22-1.5	4,0	30,7
0408020522	5/16	7,9	M22-1.5	5,5	30,7
0408020622	3/8	9,5	M22-1.5	7,0	30,7

**МЕТРИЧЕСКИЙ ШТУЦЕР
KÄRHER
GUN**

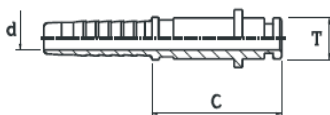

Код	Размер	рукава	Т	d	C
				дюйм	мм
0408300410	1/4	6,4	10	4,0	33,0
0408300510	5/16	7,9	10	5,5	33,0

"МНОГОРАЗОВАЯ" АРМАТУРА

ВТУЛКА ДЛЯ РУКАВА SAE 100 R1T/1SN

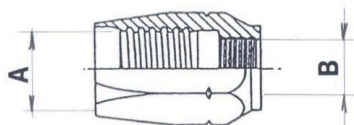

ВТУЛКА ДЛЯ РУКАВА SAE 100 R2T/2SN

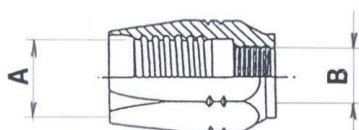

BSP ШТУЦЕР 60° КОНУС

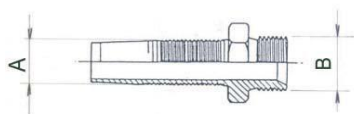

BSP ГАЙКА 60° КОНУС

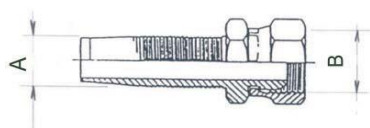

BSP 90° УГЛОВАЯ ГАЙКА 60° КОНУС

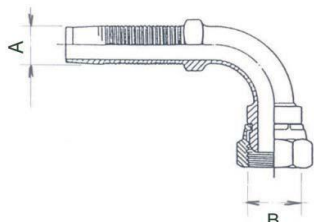

Код	рукав	A	B
дюйм			
T317100-04	1/4	12,6	9x1
T317100-06	3/8	16,3	13x1
T317100-08	1/2	19,6	5/8UNF
T317100-10	5/8	22,5	19x1,25
T317100-12	3/4	26,5	22x1,5
T317100-16	1	34,5	1.3/16F16

Код	рукав	A	B
дюйм			
T327100-04	1/4	14,0	9x1
T327100-06	3/8	17,5	13x1
T327100-08	1/2	20,0	5/8UNF
T327100-10	5/8	24,0	19x1,25
T327100-12	3/4	27,5	22x1,5
T327100-16	1	36,5	1.3/16F16

Код	рукав	A	B
дюйм			
200120-04	1/4	9x1	1/4
200120-06-4	1/4	9x1	3/8
200120-06	3/8	13x1	3/8
200120-08-6	3/8	13x1	1/2
200120-08	1/2	5/8 UNF	1/2
200120-10	5/8	19x1,25	5/8
200120-12-10	5/8	19x1,25	3/4
200120-12	3/4	22x1,5	3/4
200120-16-12	3/4	22x1,5	1
200120-16	1	1.3/16 F16	1

Код	рукав	A	B
дюйм			
200010-04	1/4	9x1	1/4
200010-06-04	1/4	9x1	3/8
200010-06	3/8	13x1	3/8
200010-08-06	3/8	13x1	1/2
200010-08	1/2	5/8 UNF	1/2
200010-10-08	1/2	5/8 UNF	5/8
200010-10	5/8	19x1,25	5/8
200010-12-10	5/8	19x1,25	3/4
200010-12	3/4	22x1,5	3/4
200010-16	1	1.3/16 F16	1

Код	рукав	A	B
дюйм			
200510-04	1/4	9x1	1/4
200510-06	3/8	13x1	3/8
200510-08-06	3/8	13x1	1/2
200510-08	1/2	5/8 UNF	1/2
200510-10	5/8	19x1,25	5/8
200510-12-10	5/8	19x1,25	3/4
200510-12	3/4	22x1,5	3/4
200510-16-12	3/4	22x1,5	1
200510-16	1	1.3/16 F16	1

BSP 45° УГЛОВАЯ ГАЙКА 60° КОНУС

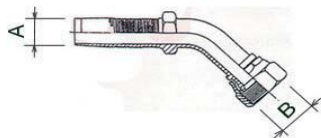

Код	рукав	A	B
дюйм			
200610-04	1/4	9x1	1/4
200610-06	3/8	13x1	3/8
200610-08	1/2	5/8 UNF	1/2
200610-10	5/8	19x1,25	5/8
200610-12-10	5/8	19x1,25	3/4
200610-12	3/4	22x1,5	3/4
200610-16-12	3/4	22x1,5	1
200610-16	1	1.3/16 F16	1

ЛС ГАЙКА 74° КОНУС

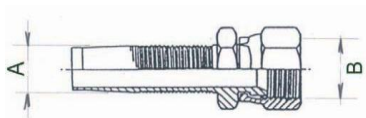

Код	рукав	A	B
дюйм			
200050-04	1/4	9x1	7/16 UNF
200050-06-04	1/4	9x1	9/16 UNF
200050-06	3/8	13x1	9/16 UNF
200050-08-06	3/8	13x1	3/4 UNF
200050-08	1/2	5/8 UNF	3/4 UNF
200050-10-08	1/2	5/8 UNF	7/8 UNF
200050-10	5/8	19x1,25	7/8 UNF
200050-12-10	5/8	19x1,25	1.1/16 UNF
200050-12	3/4	22x1,5	1.1/16 UNF
200050-16	1	1.3/16 F16	1.5/16 UNF

ЛС 90° УГЛОВАЯ ГАЙКА 74° КОНУС

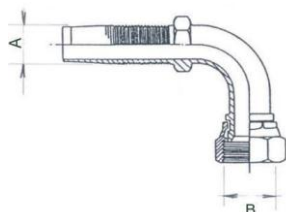

Код	рукав	A	B
дюйм			
200540-04	1/4	9x1	7/16 UNF
200540-06-04	1/4	9x1	9/16 UNF
200540-06	3/8	13x1	9/16 UNF
200540-08-06	3/8	13x1	3/4 UNF
200540-08	1/2	5/8 UNF	3/4 UNF
200540-10-08	1/2	5/8 UNF	7/8 UNF
200540-12-10	5/8	19x1,25	1.1/16 UNF
200540-12	3/4	22x1,5	1.1/16 UNF
200540-16	1	1.3/16 F16	1.5/16 UNF

ЛС 45° УГЛОВАЯ ГАЙКА 74° КОНУС

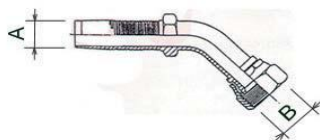

Код	рукав	A	B
дюйм			
200640-04	1/4	9x1	7/16 UNF
200640-06-04	1/4	9x1	9/16 UNF
200640-06	3/8	13x1	9/16 UNF
200640-08	1/2	5/8 UNF	3/4 UNF
200640-10-08	1/2	5/8 UNF	7/8 UNF
200640-10	5/8	19x1,25	1.1/16 UNF
200640-12	3/4	22x1,5	1.1/16 UNF
200640-16	1	1.3/16 F16	1.5/16 UNF